

1

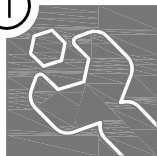

Bica Cascata - Waterfall Spout - Cascade Bec

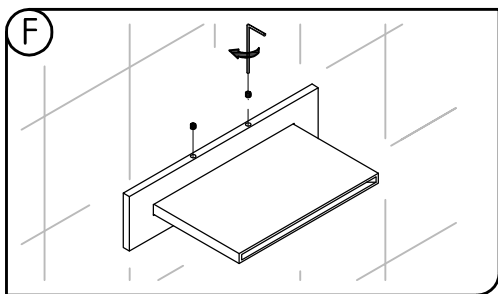
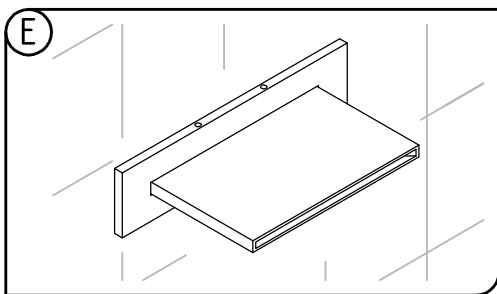
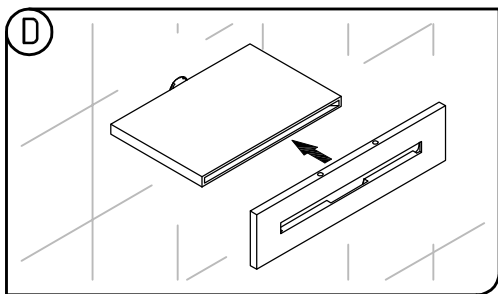
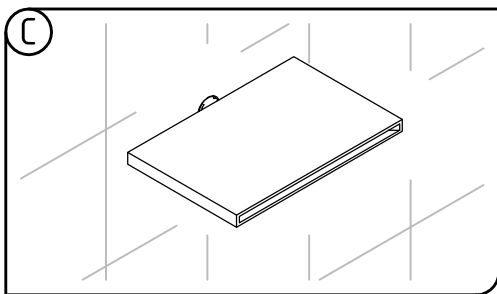
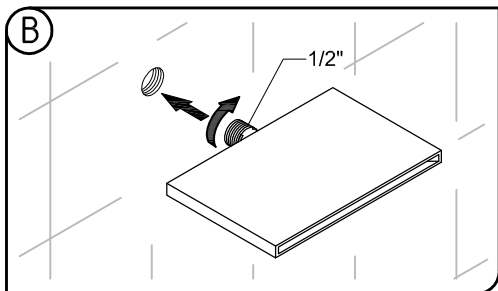
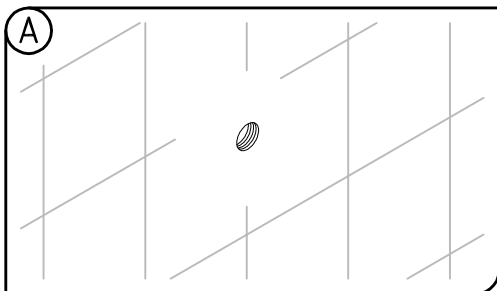
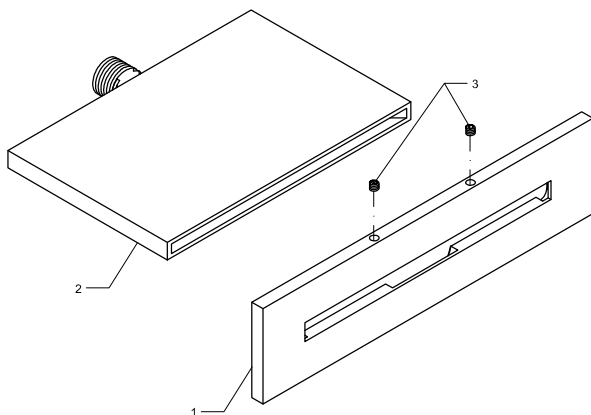

4

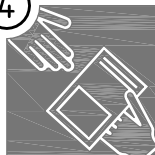

## PT - GARANTIA

A empresa garante o bom funcionamento deste produto durante **5 ANOS**, a partir da sua data de compra, contra qualquer defeito de fabrico, visível ou não, sempre que a sua montagem, uso e manutenção estejam de acordo com as normas de utilização e manuseamento. Qualquer peça defeituosa deverá ser remetida à empresa, com portes pagos e o comprovativo de compra, para ser analisada. A garantia não inclui custos de mão-de-obra, deslocações ou indemnizações.

## EN - WARRANTY

The company guarantees the correct operation of this product for **5 YEARS**, from the date of purchase, against any manufacturing defects, visible or not, as long as the assembly, use and service, are in accordance with the handling and use instructions. Any defective fitting must be sent, postage paid, to company for examination, together with the proof of purchase to validate the process. The warranty does not cover labour charges, call-out fees or indemnification.

## FR - GARANTIE

Nous garantissons le bon fonctionnement de ce produit durant **5 ans**; à partir de sa date d'achat; contre tous défaut de fabrication, visible ou non, dès que son installation et usage soit en accords avec les normes prescrites et envisagées pour son installation et utilisation. Tous produit avec défaut nous devra être remis, avec justificatif de frais de ports e achat pour être analysé. La garantie du fabricant ne contemple pas les coûts de main d'oeuvres, déplacement ou autres indemnités.

5

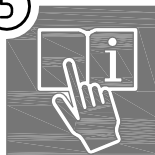

## PT - INFORMAÇÃO TÉCNICA

- 1) Espelho
- 2) Bica Cascata
- 3) Parafusos de fixação

## EN - TECHNICAL INFORMATION

- 1) Wall Plate
- 2) Waterfall Spout
- 3) Fixing screws

## FR - INFORMATION TECHNIQUE

- 1) Enjoliveur au mur
- 2) Cascade Bec
- 3) Vis



SANITANA - Fábrica de Santárlos de Anadia S.A. - Zona Industrial de Anadia - Apartado 45  
3781-909 Anadia (Portugal) - T.:+351 231 519 500 - F.:+351 231 511 024 - e-mail: info@sanitana.com - assistencia.apoio@sanitana.pt  
[www.sanitana.com](http://www.sanitana.com) - [www.sanitanaprofissional.com](http://www.sanitanaprofissional.com)

---

All Information and dimensions should be considered merely approximate and are subject to modification without notice. This document cancels the former ones.  
Toutes les dimensions et informations sont à titre indicatif et susceptibles de modifications sans préavis. Ce document annule les précédents.

Las medidas e información son a título orientativo y susceptibles de modificación sin previo aviso. Este documento anula los anteriores.

As informações e medidas são a título orientativo e susceptíveis de modificações sem aviso prévio. Este documento anula os anteriores.

---



This Company respects nature, and therefore all our manuals are printed with papers that help to maintain the environment, using only ECF pulp derived from renewable forests.

Cette société respecte la nature et c'est donc pour cela que tous nos manuels sont imprimés avec du papier qui aide l'environnement, en utilisant seulement les pâtes ECF provenant de bois renouvelables.

Esta empresa respeta la naturaleza, y por ello todos nuestros manuales están impresos con papeles que ayudan a mantener el medio ambiente, utilizando únicamente pastas ECF procedentes de bosques renovables.

Esta Empresa respeta a natureza, por isso, todos os nossos manuais são impressos com papéis que ajudam a manter o meio ambiente, utilizando pastas ECF provenientes de florestas renováveis.